

ZAION™

Bathroom Ceiling Ventilation Fan

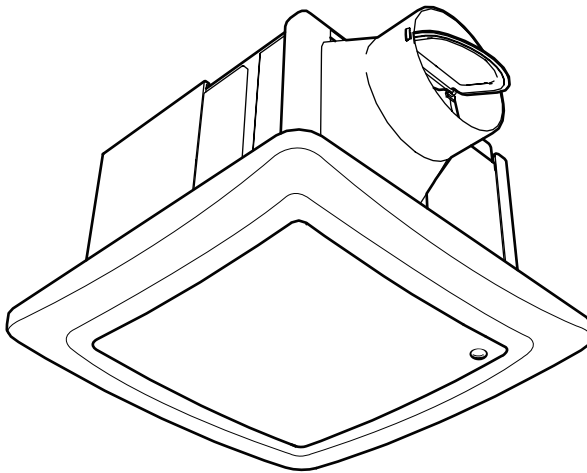

User Manual





- Thanks for your purchase of a product of HIMPEL Co., Ltd.
- Please read this instruction manual carefully before use so that you may use the product long, more conveniently and safely.
- You must read 「Instructions for Safety」 before use and use the product correctly.
- Model: HV-180, HV-200, HV-250

Instructions for Safety











This instruction manual contains cautions for safe, how to install the product, etc in regard to the bathroom ventilation fan manufactured and distributed by our company. Please read carefully cautions for safe, operation, application and tips for checking, etc before use.

This product is a ventilation device to exhaust the polluted air in toilets and bathrooms of buildings such as apartment, high-rise residential building, shopping center, office, etc, which is made to realize a pleasant indoor environment by a constant exhaust.







Cautions for Safe

 Warning!	<p>It may lead to the user's death and serious injury if ignoring instructions.</p>		<p>It is a sign to call attention to things and operation having a potential danger. In order to avoid any danger, please examine carefully and follow instructions.</p>
 Caution!	<p>It may lead to the user's injury and damage to property if ignoring the instructions.</p>		<p>It is a sign to indicate the usage which must be avoided to prevent dangers.</p>

Warning

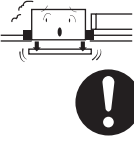
	<p>Do not disassemble Never disassemble, repair or modify the product at your discretion. It may cause an electric shock, fire or injury.</p>		<p>No wet hands Do not handle the power switch with wet hands. You may get an electric shock or get injured.</p>
	<p>Get grounding connection. It may cause damage to the product and electric shock.</p>		<p>If the power cord is damaged, stop using the product. You may get an electric shock or get injured.</p>
	<p>Do not allow water to enter electrical parts (motors, etc). It may cause equipment failure and an electric shock.</p>		<p>Do not turn on or off the switch of the fan when gas is leaking. The spark of switch may cause explosion of gas.</p>
	<p>Cut off the power supply during installation or repair. You may get an electric shock or get injured.</p>		<p>Prohibition of use of slation for other purpose. This unit is for the bathroom only.</p>
	<p>If the supply cord is damaged, it must be replaced by the manufacturer, its service agent or similarly qualified persons in order to avoid a hazard.</p>		<p>Children should be supervised to ensure that they do not play with the appliance.</p>

Cautions

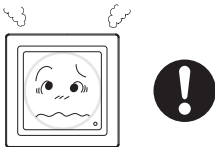
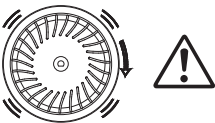
 <p>Please check if the installation of ceiling support and brace bar is correct. Due to poor installation of a product, the product may fall.</p>	 <p>Do not use it for the direct discharge in a place where there are a lot of fumes. The life of the product may be shortened.</p>
 <p>Please do not use for a long period of time around heaters or in a place the ambient temperature is over 40°C. The product may be transformed or the insulation of electrical parts may be a damaged.</p>	 <p>Please make sure that the main body and grille are installed correctly. Dropping may cause injury.</p>
 <p>During operation please do not put fingers or objects in the fan blade. Equipment failure and injuries may be caused.</p>	 <p>Do not clean using thinner, benzene, chemicals, etc, fire, deformation, Discoloration may occur.</p>
 <p>This appliance is not intended for use by persons(including children) with reduced physical sensory or mental capabilities, or lack of experience and knowledge, unless they have been given supervision or instruction concerning use of the appliance by a person responsible for their safety.</p>	
	<p>If there is any abnormal sound, smell or smoke from the product during operation, cut off the power supply immediately and contact A/S center.</p>
	<p>The noise of the fan may be little louder or smaller than usual. It is a normal phenomenon to change rotations of the fan for a certain exhaust.</p>

Parts name

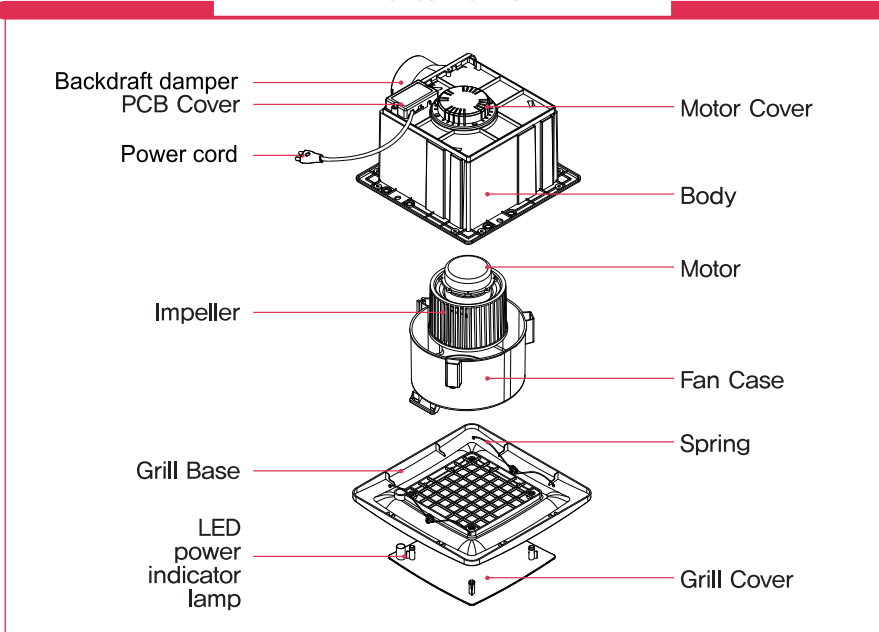

The surroundings of fan and grille are easily stained with dust or smokes, so they should be cleaned regularly every 2~3 months.
(However, the cleaning cycle may vary depending on severity of contamination.)

- Make sure that the power supply is cut off for safety before cleaning the inside of the fan.
- Make sure that water is prevented from getting into the body during cleaning.
- Use a neutral detergent for cleaning the grille.
- Wear gloves when cleaning the product.

Specifications

Model	HV-180	HV-220	HV-250
Power Voltage	1 ϕ / 230V / 50Hz		
Air Volume(CMH / CFM)	178 / 105	190 / 112	223 / 131
Power(W)	30	35	36
Noise(dB)	40	42	44
Size(mm)	320(W) X 320(D) X180(H)		
Weight(kg)	2.7		

* The specification may be changed in each country.

Check point before installation



This product is a device installed on the ceiling of indoor space to exhaust the polluted air of indoor to the outside.



This product is installed on the ceiling side at 2-3m high from the floor, so pay attention to safety to avoid falling down or fall of the product during installation.



Secure the location and space for installation and check abnormal sound of the product, opening and closing of the damper and any other troubles before installation.

Installation Process

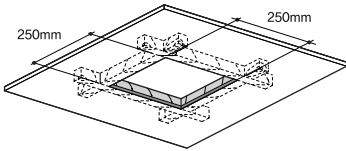

- Ceiling construction conditions
Making a hole, 250 X 250mm of the ceiling and installing brace bar

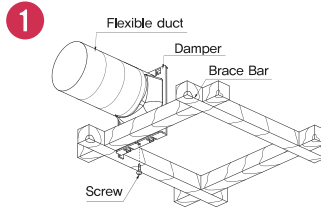

- Flexible duct installation and connection of the exhaust damper

2

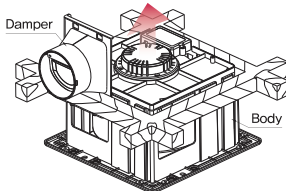

- Assembling body and damper

3

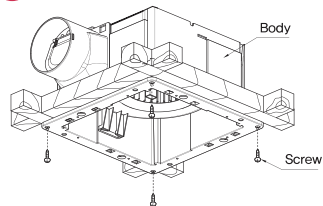

- Fixation and installation of body and ceiling

4

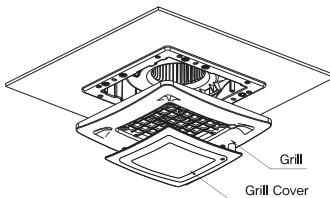

- Installation of grill and grill cover

Product Specifications

■ HV-180 / HV-220 / HV-250

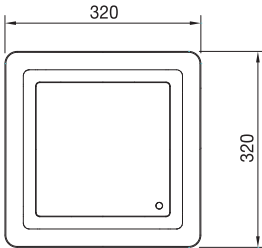

■ Dimension

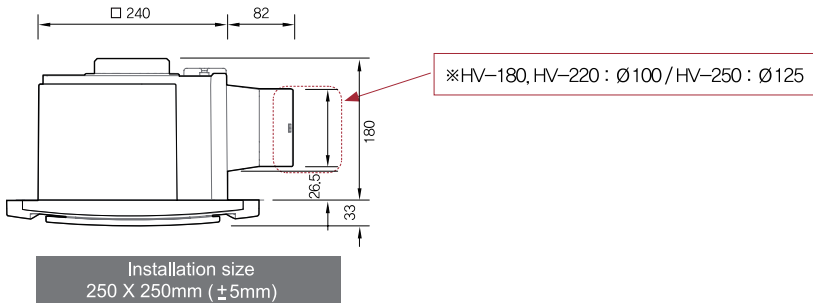

Checkpoints before A/S request

Condition	Cause	Measures
Not operated	1. Power failure	Wait until power is supplied.
	2. Power switch OFF	Make sure that the fan switch is in ON position.
Loud noise	1. Uneven level fixing of the fan	Reinstall the fan to maintain level and tighten the screw completely.
	2. Sharp bending of the duct	Spread the discharge side of duct gently.



Product warranty



Regarding the service

Himpel has implemented the product warranty as follows in accordance with compensation regulation for consumers' damages on each item. Upon the service request, such service shall be conducted by Himpel service or designated cooperative companies.

The notification of content and whether the compensation shall be made will be given within 7 days from the requested date, and the compensation for damages shall be settled within 14 days from such notification date.

Name of product		Name of model	
Purchased date	Date Month Year	Purchased price	
Agent purchased from			

Service

If the product has been breakdown during its usage, the customer shall be entitled to be serviced without a charge of fee for 1 year after the date of completed installation. However, if the product has been breakdown due to the mistake of customer or natural disaster, the repair shall be charged with a fee even if it is in the non-chargeable period.

A/S fee is comprised of engineering fee, component cost, and on-site visitation fee.

- Engineering fee is the expense of inspection upon the completion of repair, component replacement and adjustment for the diagnosis & breakdown area.
- The component cost is the expense of component & other materials used in repair.
- The on-site visitation fee is the cost of dispatch A/S personnel to the location of product upon the request of customer.

Free service

During the warranty period, the defects of device & equipment itself other than careless handling or operation of customer shall be repaired & replaced without a charge.

The claim for warranty shall be categorized as follows;

- When the excessive noise has occurred due to unbalanced fan or any other abnormalities.
- When the actual operation is not consisted with the status of control mode.
- When the power is normally supplied but the fan is not working.

Paid service

- When the customer disassembles/assembles the equipment with own discretion and caused abnormalities on operation.
- When the product has been damaged due to wrong connections.
- Replacement of grille cover which is replaceable component
- Periodic inspection & maintenance

※Please keep it along the owner's manual as it will not be reissued.

Customer service : + 82-31-424-8403

Head office : Annyeongnam-ro 8beon-gil 4, Hwaseong-si, Gyeonggi-do, Republic of Korea

HIMPEL



HIMPSEL

HIMPSEL

Head office/Plant

Annyeongnam-ro 8beon-gil 4,
Hwaseong-si, Gyeonggi-do,
Republic of Korea